

ACCORDION

FOLDING PARTITIONS



HUFCOR[®]

WORLD LEADER IN FLEXIBLE SPACE MANAGEMENT



HUF COR ACCORDION

FOLDING PARTITIONS



The Industry's Most Attractive and Durable Accordion Doors

Hufcor accordion partitions are the fastest and most economical way to organize space and insulate against distracting noise. They provide instant privacy for meetings, classes, or office and work areas.

Accordion doors are the fastest, easiest way to divide space. You simply pull the door across the opening and latch in position. Accordions are a great choice when you need to divide your space frequently.

Hufcor accordion partitions are available in a selection of models: non-acoustically rated models 1500 and 2000; and acoustically rated models 3100, 3500, 3900, 4100 and 4500. The model number also references the acoustical rating (example: model 3100 has a Sound Transmission Class (STC) rating of 31, model 3500 is rated STC 35, etc.).

All Hufcor accordion doors have an internal steel pantograph for smooth, even extension whether the door goes wall-to-wall, through intersections, or around curves. Two semi-rigid, laminated covers are attached to the pantograph. The cover design provides strength and stability as well as resistance to punctures, tears, rips or cuts.

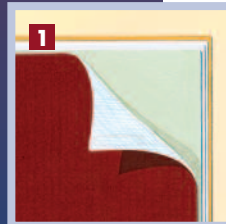
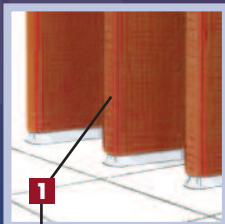

Before choosing an accordion door, compare the added value available from Hufcor:

1. Wrinkle-free, impact resistant laminated covers provide a smooth symmetrical appearance – not the drapery look provided by other manufacturers. If you decide to change your décor, or, if damage should occur, Hufcor can replace the cover or portions of a cover, rather than replace the entire door. Concealed inside each door is a factory registration slip with all the information needed to properly match your new cover with the original.



2. A selection of heavy duty aluminum track systems is available to accommodate various ceiling conditions and provide sufficient support for each door.

3. Steel ball bearing trolley with nylon tires supports the door every 18"-21" and provides smooth, quiet operation.

4. Adjustable lead carrier allows proper alignment of the partition's leading edge for effective latching at all times and enables the door to adjust to out-of-plumb conditions.

5. The precision-engineered steel internal pantograph provides years of smooth, easy folding action and allows the door to easily maneuver curves and switches.

ACOUSTICAL
MODEL SHOWN

ACCORDION SPECIFICATIONS

Construction

Hufcor's accordion doors consist of two laminated covers assembled to steel pantographs supported by aluminum covered steel channel posts at each end. Covers are of a semi-rigid laminated construction for wrinkle-free impact resistance.

Non-Acoustical Models 1500 & 2000:

Covers have fiberboard strips and backing laminated within each fold. Model 2000 has sweepstrips top and bottom of one side.

Acoustical Models 3100, 3500, 3900, 4100 & 4500: Similar to the Model 1500, but with the addition of multi-ply sweepstrips top and bottom both sides and the lead post has the Magnaseal® magnetic contact latch. Steel strips are laminated within each fold for models 3500, 3900, 4100 and 4500. The higher the sound rating, the heavier the gauge of steel used.

Suspension System

Accordion doors are supported by nylon-tired steel ball bearing carriers. The track is clear anodized aluminum. Curves and switches are available to enable the doors to be used or stored in alternate or remote locations.

Finishes

The standard finish is factory applied vinyl from Hufcor's standard vinyl selector. Premium carpet, fabric or pre-approved custom finishes are available.

Acoustics

The acoustical performance of acoustical models shall have been tested at an independent testing facility in accordance with ASTM E90 test standards.

Operation

Standard partitions are manually operated. Electric operation is available.

ISO Registration

Hufcor U.S. manufacturing facilities' quality system is registered to the ISO 9001 standards.

Warranty

Partitions are guaranteed for two years and the pantographs, trolleys and tracks are guaranteed for 10 years.

Complete specifications and details are available on the Hufcor website, www.hufcor.com, or may be found in our Architectural Product Manual.

Typical Jamb Configurations



Pair of doors anchor at both jambs. Bi-parting doors may be of equal or unequal width.

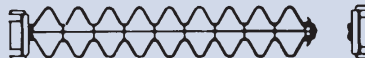

Single doors anchor at either jamb.

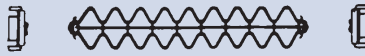

Rolling post doors permit stacking at either jamb. Use in a series for long openings.

MODELS 1500-4500

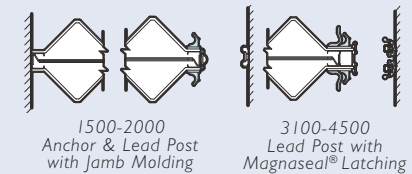
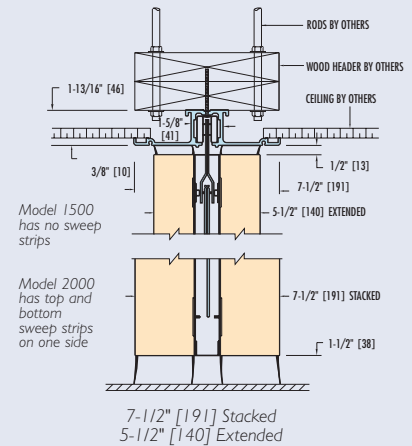

CHART A ACCORDION MODEL SELECTOR

Model	STC ¹ Rating	Lbs./Sq. Ft. [Kg/Sq.M]	Stack Dimensions ²
1500	15 (est)	1.3 [6.3]	1.4"/ft. + 2" [117 + 51]
2000	20 (est)	1.3 [6.3]	1.4"/ft. + 2" [117 + 51]
3100	31	2.7 [13.2]	1.9"/ft. + 3" [158 + 76]
3500	35	3.0 [14.6]	1.9"/ft. + 3" [158 + 76]
3900	39	3.7 [18.1]	1.9"/ft. + 3" [158 + 76]
4100	41	4.3 [21]	1.9"/ft. + 3" [158 + 76]
4500	45	5.1 [24.9]	1.9"/ft. + 3" [158 + 76]

¹ Sound Transmission Class. ² Add 30% to stack dimension for carpet. Carpet provides .55 NRC rating. Single Door Maximum Width 40" [1016]. Maximum Height 17'0" [5181]. For sizes in excess of these contact your Hufcor distributor.

ACCORDION TRACK SYSTEMS

TYPE 50

Heavy-Duty Extruded Aluminum, Recessed or Exposed

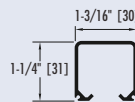

TYPE 71

Heavy-Duty Extruded Aluminum, Recessed Only

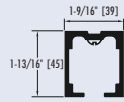

TYPE 15

Heavy-Duty Extruded Aluminum with Built-in "Ceiling Saver" May be direct attached or suspended from hanger rods (shown with optional hanger bracket and rods)

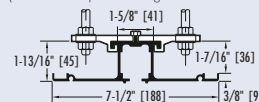

TYPE 18

Heavy-Duty Extruded Aluminum with Built-in "Ceiling Saver"

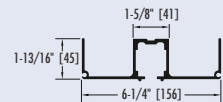

Track Types	Type 50	Type 71	Type 15	Type 18
Models 1500 -2000	Widths to 20'0" or heights to 10'0" [6.09 x 3.04]**	Optional All Sizes	Optional All Sizes	Optional All Sizes
Models 3100, 3500, 3900	Widths to 20'0" or heights to 10'0" [6.09 x 3.04]**	Optional All Sizes	Optional All Sizes	Optional All Sizes
Models 4100, 4500	Not Available	Optional All Sizes	Optional All Sizes	Optional All Sizes

**If size exceeds either dimension shown, use alternate track.

Channel: Optional, but recommended for recessed installations. Channel provides smooth, straight ceiling lines; aids track installations. Flanges on both sides protect ceiling. Primed off-white.

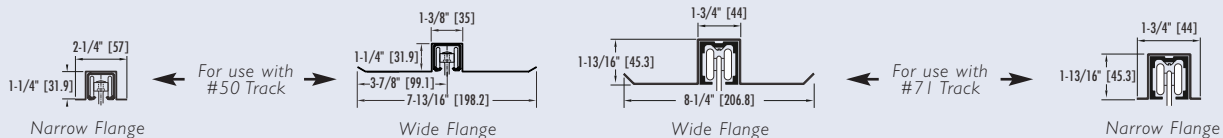

Note: metric dimensions are in []



ACCORDION OPTIONS

Curved Tracks

Curved tracks are available in type #15, #50 and #71 track. Stock curves: 3'6" and 5'0". Custom curves to specification. No structural modifications required. Curved installations require extra door fullness. Add to partition width as follows:

Radius	Add
3'6" and 5'0"	Total of squared corner for door width

S Curves

Std. 10" offset available in #15, #50 and #71 track only. Custom curves also available.

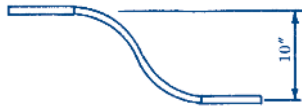

Multiple Meeting Posts

Multiple Meeting Posts allow more than one door to latch together and are available in two, three or four-way meeting arrangements. Available in either "floating" or "attached" type post.

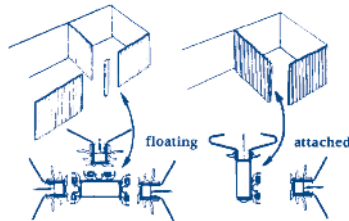

Intermediate Posts

Intermediate Posts are for latching one door to another at an intermediate location. Available one or both sides.



Switching

Switching partitions from one track to another allows any partition to serve a dual purpose, or allows remote stacking arrangement. (Refer to Hufcor ARCHITECTURAL MANUAL for framing details.)

Glide Switch

Glide Switch moves partition from straight onto curved track, permits partition to be used in an alternate track at right angles to the main run or to stack parallel along the wall.

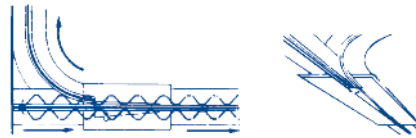

Crossover Switch

Crossover Switch permits partitions to pass through intersections.

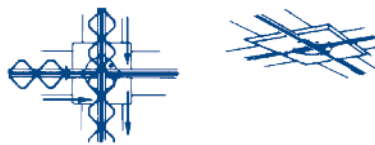

STORE YOUR ACCORDION DOOR OUT OF SIGHT.

Pocket Width

- 10" Minimum - Doors up to 10' wide
- 11" Minimum - Doors up to 20' wide
- 12" Minimum - Doors up to 30' wide

Pocket Storage with Rolling Jamb

Optional pocket door (by others).

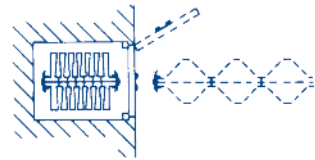

Pocket Storage with Sliding Jamb

Optional pocket door (by others). When extended, door moves to front of pocket.

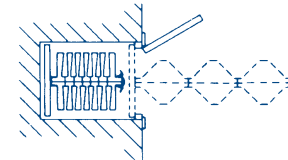

Electric accordions are also available. Contact your Hufcor Distributor for information.

For installations requiring taller heights, work surfaces or greater sound control, consider our extensive line of operable or portable partitions. Contact your Hufcor representative for details.



IT'S ALL IN THE BOOK

More details on all Hufcor products are available in the Architectural Product Manual. Call your local rep today to receive a complimentary copy.

www.hufcor.com

HUFCOR[®]
World Leader in Flexible Space Management[™]

WORLDWIDE HEADQUARTERS
PO Box 591 / 2101 Kennedy Road, Janesville, WI 53547
Toll-Free: 800-542-2371, ext. 214
Telephone: 608-756-1241
Fax: 608-758-8253
E-mail: info@hufcor.com
Web: www.hufcor.com



F-4268A MTHSS 5M Printed in U.S.A. Hufcor reserves the right to improve and change product without notice.



Hufcor offers continuing education programs for AIA members. Contact your Hufcor representative for details.



*USGBC and related logo is a trademark owned by the U.S. Green Building Council and is used by permission.